

Powered by



# HRL 12110W ▶ 12V 110W

HRL 12110W is specially designed for high efficient discharge application. Its characteristics are high energy density, small footprint and high discharge efficiency. It can be used for more than 260 cycles at 100% discharge in cycle service, up to 10 years in standby service.



## Specification

Cells per unit	6
Voltage per unit	12
Capacity	110W @ 15min-rate to 1.67V per cell @25 °C(77°F) 27.5 Ah @ 20hr-rate to 1.75V per cell @25°C (77°F)
Weight	Approx.9.9 kg(21.83 lbs)
Maximum Discharge Current	400A(5sec)
Internal Resistance	Approx. 9 mΩ
Operating Temperature Range	Discharge: -15°C~50°C( 5°F~122°F) Charge: -15 °C~40°C( 5°F~104°F) Storage: -15°C~40°C( 5°F~104°F)
Nominal Operating Temperature Range	25°C±3°C (77°F±5°F)
Float Charging Voltage	13.5 to 13.8 VDC/unit Average at 25°C (77°F)
Recommended Maximum Charging Current Limit	11A
Equalization and Cycle Service	14.4 to 15.0 VDC/unit Average at 25°C (77°F)
Self Discharge	CSB Batteries can be stored for more than 6 months at 25°C (77°F). Please charge batteries before using. For higher temperatures the time interval will be shorter.
Terminal	I1-Thread lead alloy recessed terminal to accept M5 bolt
Container Material	ABS(UL 94-HB/File E50263)*Flammability resistance of (UL 94-V0/File E88637) can be available upon request.



CSB-manufactured batteries are UL-recognized components under UL924 and UL1989. CSB is also certified by ISO 9001 and ISO 14001.

Dimensions :	Overall Height (H)	Container height (h)	Length (L)	Width (W)
	Unit: mm (inch)	175±2 (6.89±0.08)	166.5±2 (6.55±0.08)	166±2 (6.53±0.08)

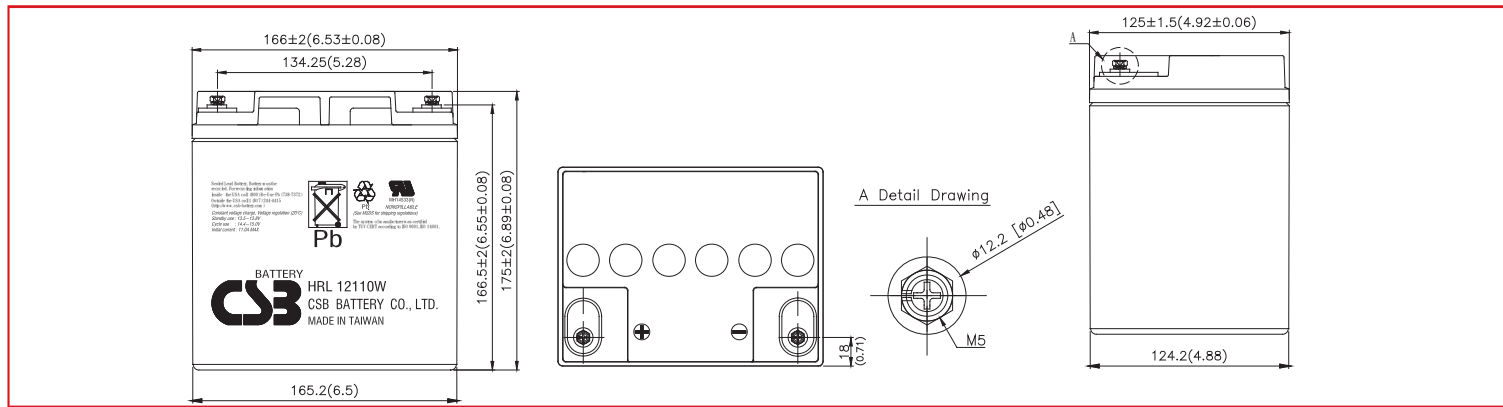

## Constant Current Discharge Characteristics Unit:A (25°C, 77°F)

F.V/Time	2MIN	4MIN	6MIN	8MIN	10MIN	15MIN	20MIN	30MIN	60MIN	90MIN
1.60V	170	145	118	97.5	81.6	61.4	48.0	33.6	21.3	14.9
1.67V	151	129	108	91.1	77.5	59.6	47.0	33.2	20.8	14.7
1.70V	141	121	103	88.3	75.7	58.6	46.3	32.7	20.4	14.5
1.75V	125	108	93.2	82.7	72.2	56.1	44.7	32.3	20.0	14.4
1.80V	109	94.0	83.7	76.4	68.7	53.7	42.5	31.9	19.6	14.2
1.85V	89.3	78.7	73.6	69.2	64.4	51.0	40.8	29.7	18.3	14.0

## Constant Power Discharge Characteristics Unit:W (25°C, 77°F)

F.V/Time	2MIN	4MIN	6MIN	8MIN	10MIN	15MIN	20MIN	30MIN	60MIN	90MIN
1.60V	1,806	1,541	1,270	1,053	888	682	554	385	247	174
1.67V	1,624	1,386	1,171	988	852	665	535	377	243	173
1.70V	1,530	1,316	1,107	956	827	655	526	372	239	171
1.75V	1,358	1,190	1,020	900	796	636	510	361	234	170
1.80V	1,177	1,054	941	851	764	610	495	352	229	168
1.85V	995	918	854	793	733	589	478	337	217	167

### Trickle (or Float) Service Life

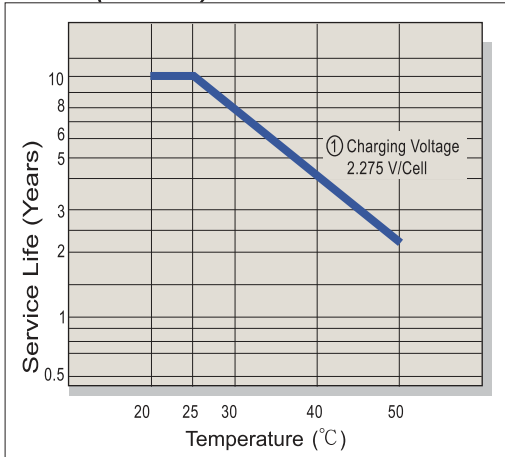

### Capacity Retention Characteristic

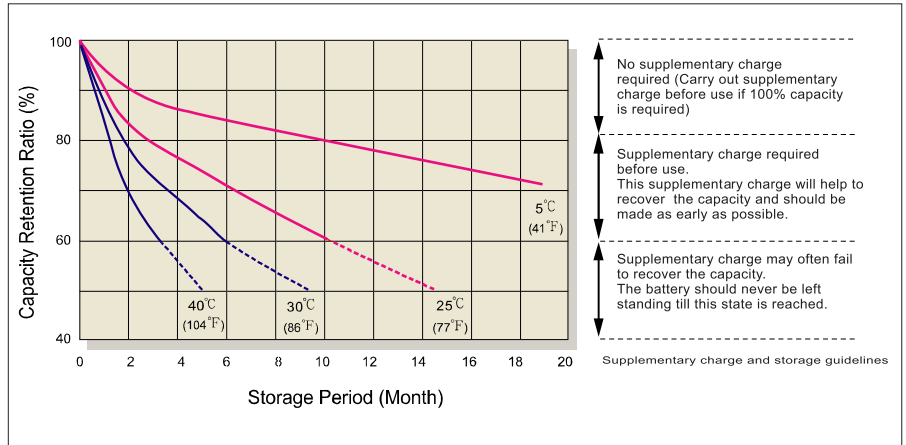

### Battery Voltage and Charge Time for Standby Use

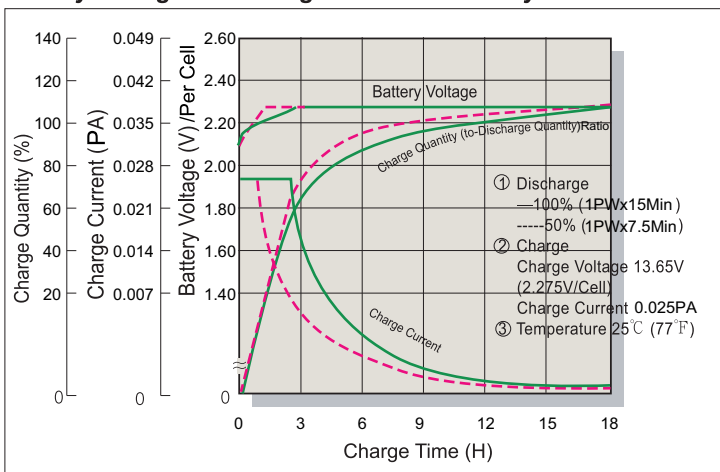

### Cycle Service Life

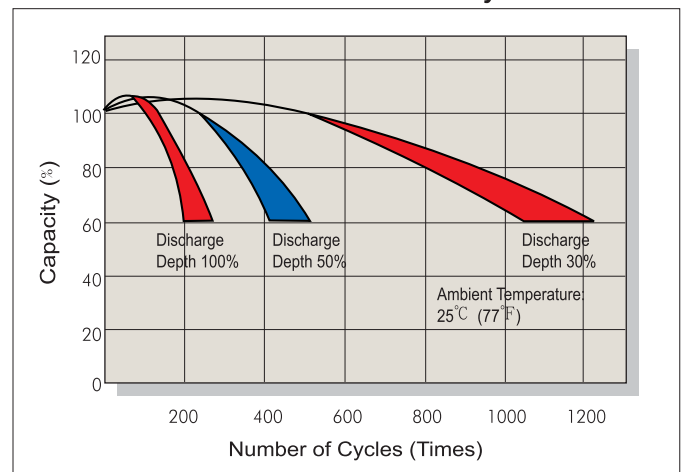

### Battery Voltage and Charge Time for Cycle Use

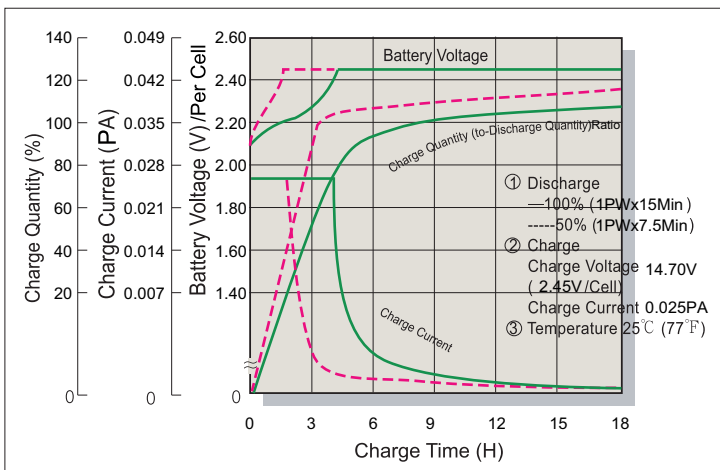

### Terminal Voltage (V) and Discharge Time

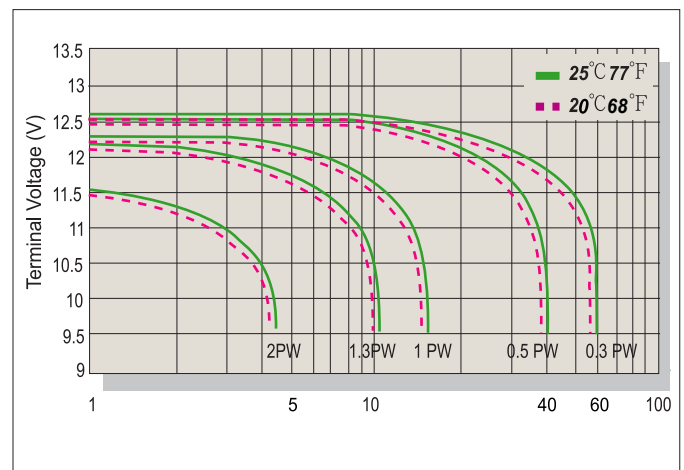

### Charging Procedures

Application	Charge Voltage(V/Cell)			Max.Charge Current
	Temperature	Set Point	Allowable Range	
Cycle Use	25°C(77°F)	2.45	2.40~2.50	0.1PA
Standby	25°C(77°F)	2.275	2.25~2.30	

### Discharge Current VS. Discharge Voltage

Final Discharge Voltage V/Cell	1.75	1.70	1.60	1.30
Discharge Power(W)	0.1P>(W)	0.1P≤(W)<0.25P	0.25P≤(W)<1.0P	(W)≥1.0P

Sales Office URL: [WWW.CSB-BATTERY.COM](http://WWW.CSB-BATTERY.COM)

**GLOBAL HQ**  
**CSB BATTERY CO., LTD. (TAIWAN)**  
 Tel : +886-2-2555-5600  
 Fax : +886-2-2555-3300  
 mail : service@csb-battery.com.tw

**BEIJING OFFICE. (CHINA)**  
**CSB BATTERY TECHNOLOGIES (BEIJING) CO., LTD.**  
 Tel : +86-10-59621300/1301/1302/1303  
 Fax : +86-10-59621304  
 mail : chinasl@csb-battery.com

**AMERICA HQ**  
**CSB BATTERY TECHNOLOGIES INC. (U.S.A)**  
 Tel : +1-817-244-7777/1-(800)3-CSB-USA(272872)  
 Fax : +1-817-244-4445  
 mail : csb@csb-battery.com

**SHANGHAI OFFICE. (CHINA)**  
**CSB BATTERY LOGISTIC (SHANGHAI) CO., LTD.**  
 Tel : +86-21-5046-1622/5046-0833  
 Fax : +86-21-5064-3314  
 mail : chinasl@csb-battery.com

**EUROPE HQ**  
**CSB Battery Europe BV.**  
 Tel : +31(0)-180-418-140  
 Fax : +886-2-2555-3300  
 mail : eurosales@csb-battery.eu

**SHENZHEN OFFICE. (CHINA)**  
**CSB BATTERY LOGISTIC (SHANGHAI) CO., LTD.**  
 Tel : +86-755-8831-6488/6396/6356  
 Fax : +86-755-8831-6548  
 mail : she@csb-battery.com.cn